

# HAPPY

80 cm | 31-1/2 in

VANITY UNIT

MEUBLE DE SALLE DE BAIN

MUEBLE DE BAÑO

MÓVEL DE CASA DE BANHO

ΒΑΣΗ ΕΠΙΠΛΟΥ

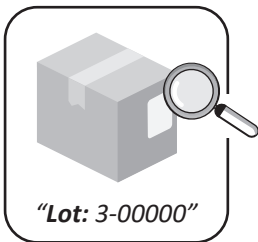
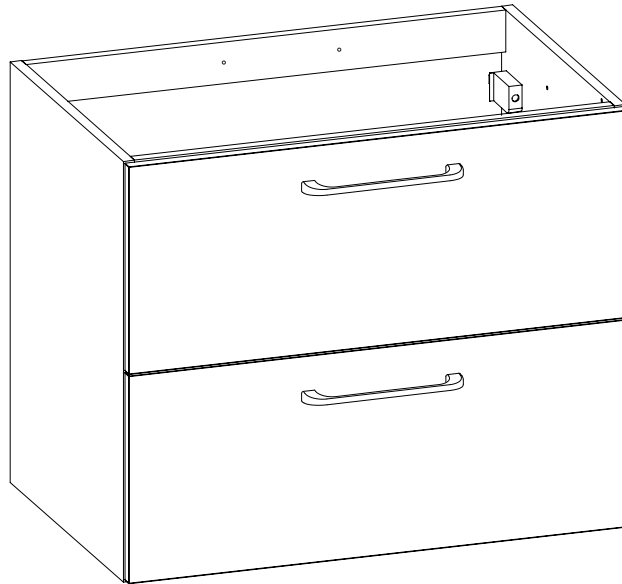

Lot:

-



**ENGLISH** - Please enter the batch number of your furniture in this box and keep this form. You must include it with the purchase ticket for after-sales service management. You will find it on the label of the outer box and on side of the furniture.

**FRANÇAIS** - S'il vous plaît, notez dans l'encadré le numéro de lot de votre meuble et conservez cette feuille. Vous devrez l'apporter avec le ticket de caisse pour toute gestion au service après-vente. Vous le trouverez sur la boîte extérieure et sur un latéral du meuble.

**ESPAÑOL** - Por favor, anote en este recuadro el número de lote de su mueble y conserve esta hoja. Deberá aportarlo junto al ticket de compra para cualquier gestión del servicio postventa. Lo encontrará en la caja exterior y en un lateral del mueble.

**PORTUGUÊS** - Por favor, insira nesta caixa o número de lote do seu móvel e guarde esta folha. Guarde o mesmo junto da factura de compra, o mesmo será útil para serviço de garantia e pós venda. O número de lote poderá ser encontrado na caixa exterior do móvel e na lateral do mesmo.

**ΕΛΛΗΝΙΚΑ** - Σας παρακαλώ πολύ καταχωρήστε τον αριθμό παρτίδας (batch number) σε αυτό το κουτάκι και κρατήστε αυτή τη φόρμα. Σε περίπτωση ποιοτικού προβλήματος θα πρέπει να την προσκομίσετε μαζί με την απόδειξη αγοράς. Τον αριθμό παρτίδας θα τον βρείτε πάνω στη συσκευασία, καθώς και στα πλαινά του επίπλου.

# HAPPY

80 cm | 31-1/2 in

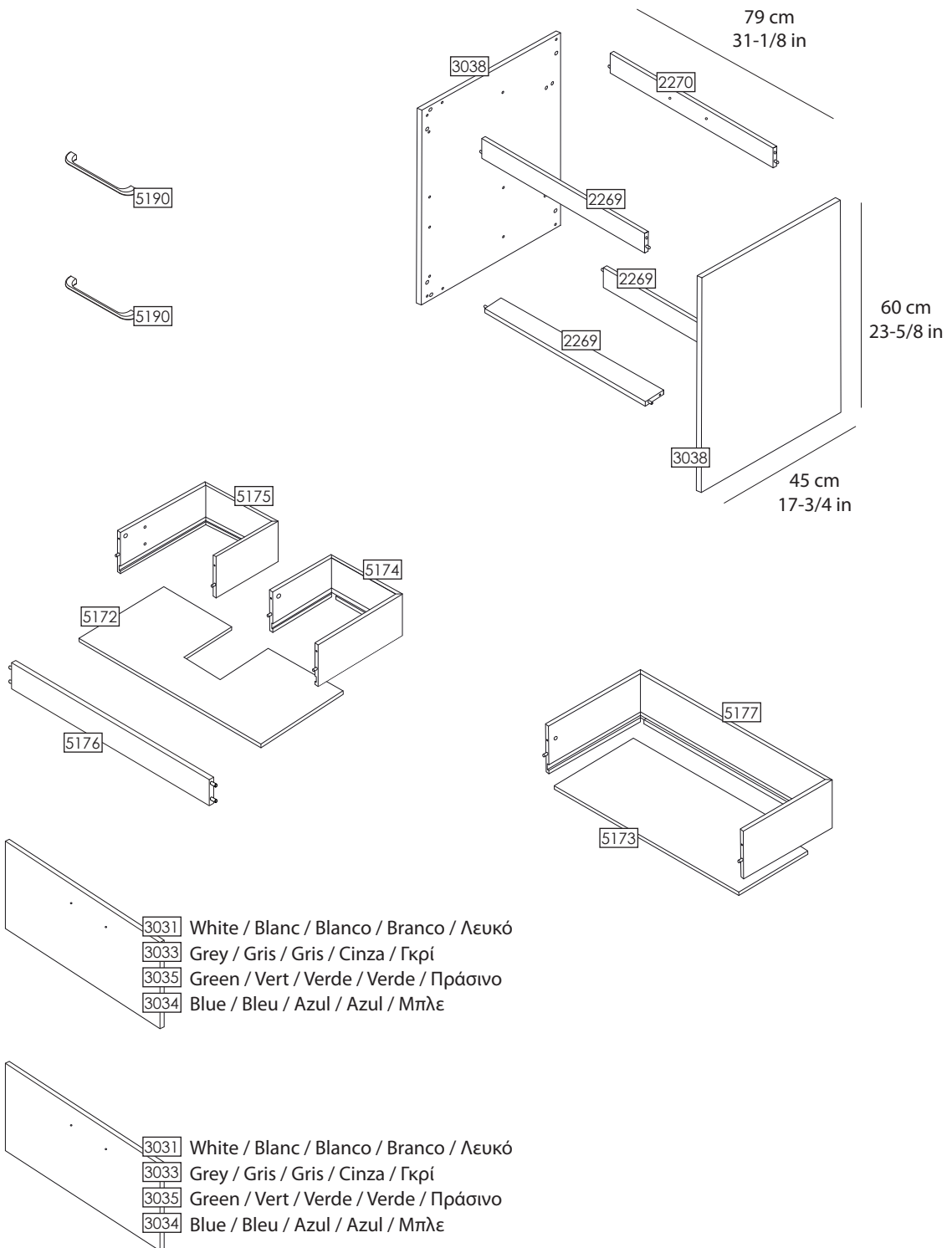

# HAPPY

80 cm | 31-1/2 in

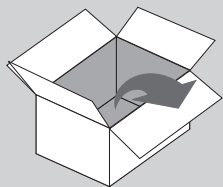

**1120**  
x12

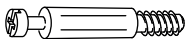

**1111**  
x8



**2124**  
x2

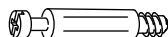

**1713**  
x6



**1108**  
x1

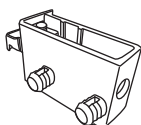

**1107**  
x1

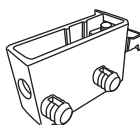

**1089**  
x2

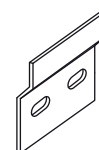

**1380**  
x2

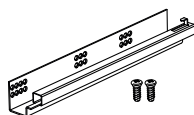

**1379**  
x2

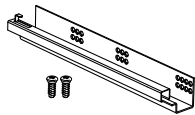

**2120**  
x4

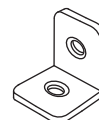

**1550**  
x4



**5113**  
x8



White / Grey  
Blanc / Gris  
Blanco / Gris  
Branco / Cinza  
Λευκό / Γκρι  
**1658 / 1881**



**1349**  
x4

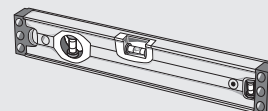
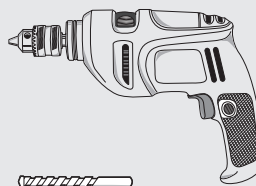
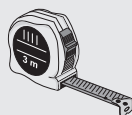
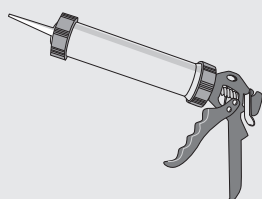
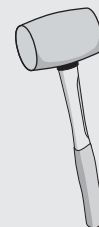
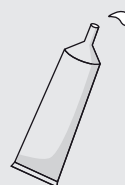
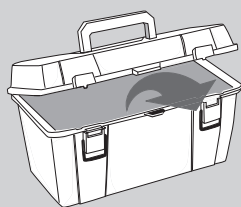



**ENGLISH** - For day-to-day cleaning, simply wipe the vanities with a soft, damp cloth and a little mild detergent if necessary. Avoid cleaning agents that include ammonia, alcohol, bleach or abrasives. Rinse afterwards with clean water and then dry with a clean, dry cloth. Do blot up spills immediately. Please avoid exposing the furniture to high concentrations of steam or other forms of moisture. Keeping your bathroom ventilated is highly recommended.



**FRANÇAIS** - Pour l'entretien habituel du meuble, nettoyez la surface avec un chiffon légèrement humidifié d'eau et séchez-le rapidement. Ne pas utiliser de lessives composées d'ammoniaque, alcool, eau de javel ou autres produits abrasifs. Il est recommandable de sécher tout versement d'eau survenu. Evitez que le meuble soit exposé à des concentrations excessives de vapeur ou autres formes d'humidité. Nous vous recommandons une bonne ventilation dans votre salle de bain.



**ESPAÑOL** - Para el mantenimiento diario de su mueble, limpie la superficie con un paño ligeramente humedecido de agua y seque rápidamente. Evite detergentes que incluyan amoníaco, alcohol, lejía u otros abrasivos. Es conveniente secar cualquier derrame de agua que se haya producido. Evite exponer el mueble a excesivas concentraciones de vapor u otras formas de humedad. Le aconsejamos ventilar bien su cuarto de baño.

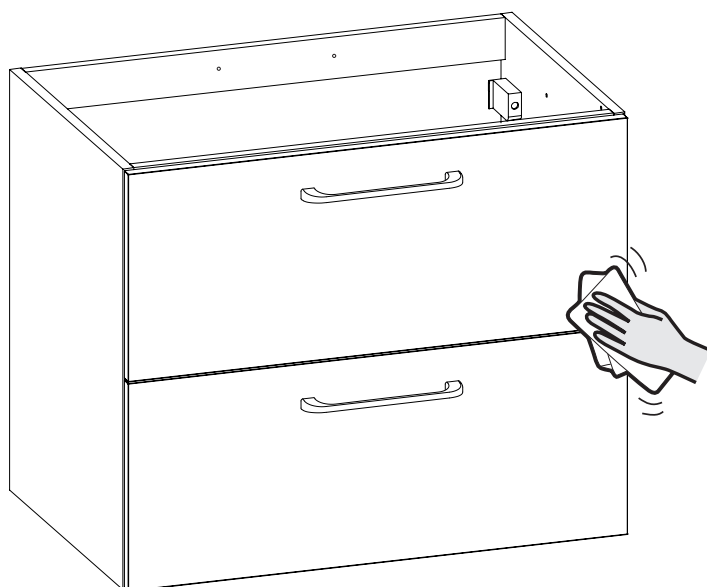

●●randalsa

Randal Europea, S.A.  
C/ Ciudad de Liria, 120  
Pol. Ind. Fuente del Jarro  
46988 Paterna · Valencia · Spain  
Tel. +00 34 961 539 000  
[www.randalsa.com](http://www.randalsa.com)  
[info@randalsa.com](mailto:info@randalsa.com)

5242.V01



**ISO 9001**

LL-C (Certification)



**ISO 14001**

LL-C (Certification)



**PEFC**

PEFC/14-35-00240

Promoviendo la gestión forestal sostenible

EMPRESA ASOCIADA  
**AIDIMME**®  
INSTITUTO TECNOLÓGICO